

Female Header 2.54mm 1 & 2 Row H=8.5mm Right Angle Type

Specifications

Current Rate: 3 AMP
 Insulation Resistance: 1000MΩ Min.
 Contact Resistance: 20mΩ Max.
 Dielectric Voltage: 1000V AC for one minute
 Operation Temperature: -40°C to +105°C

Material

Insulator: Polyester, UL 94V-0
 ©Standard: PBT or Nylon 6T
 Terminal: Copper Alloy
 Plating: Gold Plated

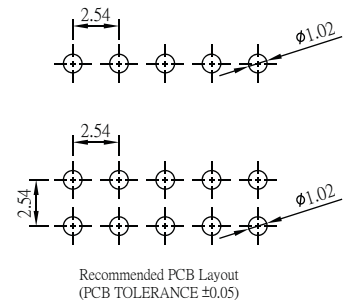
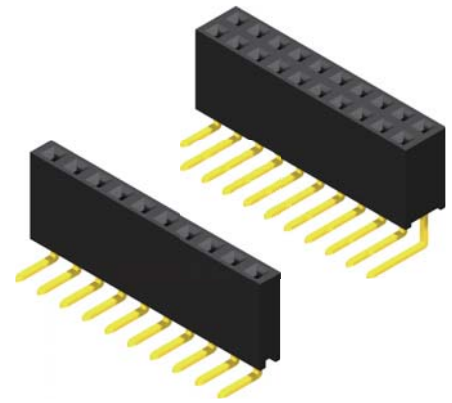
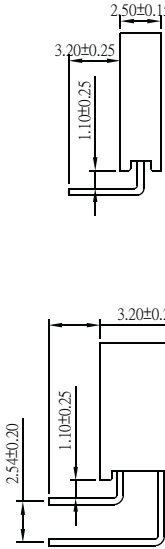
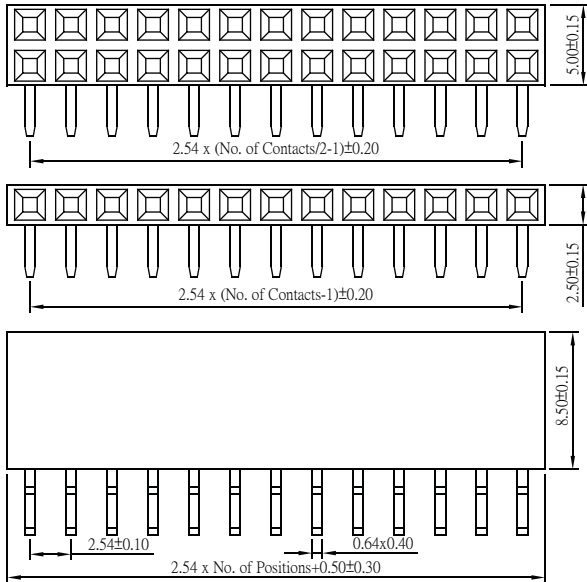

Part No.: PS1R85-1/2XX-L/U

Female Header 2.54mm 2 Row H=8.5mm With Bump Right Angle Type

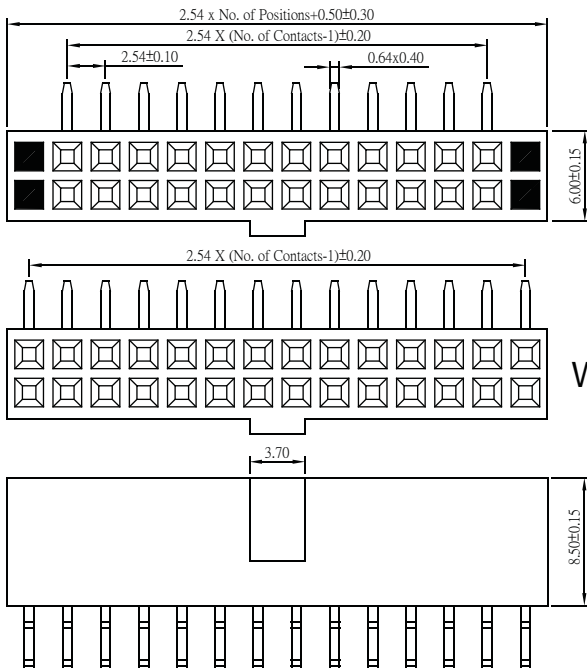

With Blocked

W/O Blocked

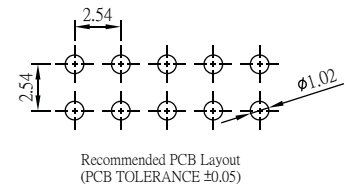
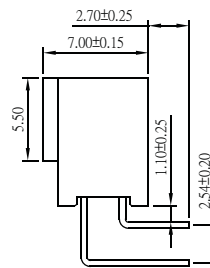

Part No.: PS1R85B-2XX-L/U

ORDER INFORMATION

